

Data Sheet



Article number: 021500700095

Description: Sealing Clamp S 95 W5

Measures

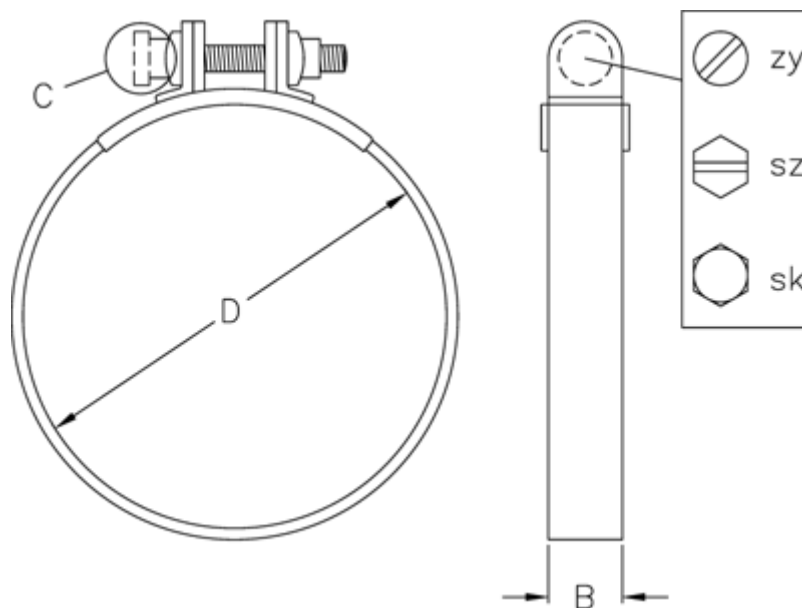

C (screw type) = SZ

Diameter D = 95

Width B = 20